



OSCAR

ROTARY LIMIT SWITCH

Oscar is a device used to control the movement of industrial machinery when in need of measuring the movement on the basis of the rotation angle and/or of the number of shaft revolutions. Oscar is made up by a gearmotor which transfers the movement to the cams and to the other movement detection devices placed inside it through a primary input reduction step (worm gear and helical toothed gear) and one or more secondary output steps (pairs of straight toothed gears).

Oscar is used on wind turbines to control the position of the nacelle or the pitch angle of the blades. The motor that controls the rotation of a wind turbine on the yaw axis (or of the blade around its longitudinal axis) transfers the movement to the limit switch. A rotary encoder reads the rotation of the shaft, and its pulses are sent to a PLC which controls the position of the nacelle or of the blade. The movement of the shaft is also transferred, through a gearmotor, to a series of cam switches: the appropriate setting of the actuating point of the cams can signal up to four critical positions of the movement of the nacelle or of the blade.

FEATURES

Revolution ratios, ranging from 1:1 to 1:1550, result from the combination of different secondary output steps. Each output of the limit switch can be set with a different revolution

ratio to allow for a diversified control of the machinery to meet special requirements.

Each cam can be set with great accuracy thanks to the cam adjusting screws. The auxiliary switches are of a positive opening type, thus suitable for safety functions.

OPTIONS

Oscar can be fitted with different combinations of actuators and motion detectors: sets of cams and microswitches (max. 12), potentiometers or encoders (max. 2), absolute encoder Yankee 1 for set of cams and microswitches (max. 2). It is possible to fit together sets of cams and microswitches, potentiometers and encoder, thus creating a device featuring redundancy and diversity.

The limit switch is available with a flange for direct coupling to the motor. Different labels and colors are also available.

MATERIALS

Oscar features transmission and gear driving shafts made of stainless steel AISI 430F or AISI 303, worm gear transmission shaft rotating on ball bearings, self-lubricating techno-polymer gears and driving bushes, techno-polymer base and cover. All techno-polymers used for the enclosure are wear resistant and protect the equipment against water and dust.



INDUSTRIAL
LIFTING



CONSTRUCTION
LIFTING



INDUSTRIAL
AUTOMATION



STAGE
TECHNOLOGY



WIND
ENERGY

STANDARDS - MARKINGS - HOMOLOGATIONS

Conformity to Community Directives:

2006/95/CE: Low Voltage Directive

2006/42/CE: Machinery Directive

- Conformity to Standards:

EN 60204-1 Safety of machinery - Electrical equipment of machines

EN 60204-32 Safety of machinery - Electrical equipment of machines
- Requirements for hoisting machines

EN 60947-1 Low-voltage switchgear and controlgear

EN 60947-5-1 Low-voltage switchgear and controlgear - Control circuit devices and switching elements - Electromechanical control circuit devices

EN 60529 Degrees of protection provided by enclosures

- Regulations for the prevention of accidents BGV C 1 (only for Germany)

- CAN/CSA-C22.2 No 14-10 - Industrial Control Equipment

- UL 508 - Industrial Control Equipment

GENERAL TECHNICAL SPECIFICATIONS

- Storage ambient temperature: -40°C/+80°C

- Operational ambient temperature: -40°C/+80°C

- Protection degree:

IP 66 / IP 67 / IP 69K

- Insulation category: Class II

- Maximum rotation speed: 800 rev./min.

- Cable entry: cable clamp M20 - M16 (max 8)

- HALT test (data available on request)

- Markings and homologations:     SIL 1

TECHNICAL SPECIFICATIONS OF THE MICROSWITCHES

- Utilisation category:

AC 15 / 250 V / 3 A max.

DC 13 / 60 V / 0.5 A max.

- Rated thermal current: 10 A max.

- Rated insulation voltage: 300 Vac

- Mechanical life: 1.5x10⁶ operations max.

- Terminal referencing: according to EN 50013

- Connections: screw-type terminals

- Markings and homologations:

PRSL0100XX:     (general purpose)

PRSL0110XX-PRSL0111XX:   

- The snap action switch PRSL0100XX has 1 NO + 1 NC change over contacts.

- The snap action switch PRSL0110XX has 1 NO + 1 NC change over contacts, double break.

- The slow action switch PRSL0111XX has 1 NC contact, double break.

All NC contacts are of the positive opening operation type .
The switches have the following reference for internal wiring.

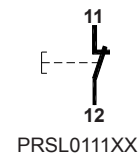
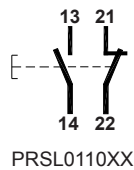
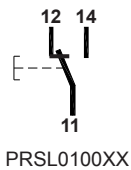

OVERALL DIMENSIONS (MM)

Standard

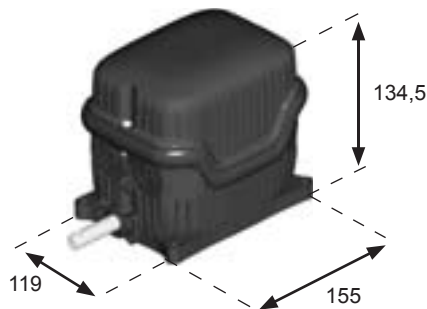

With flange

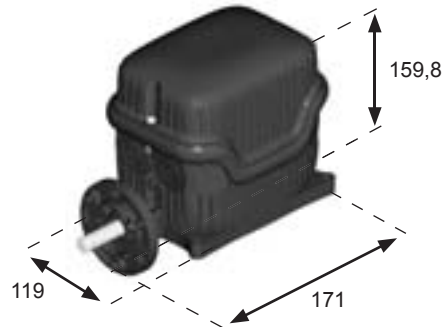

POSSIBLE ASSEMBLIES

With set of cams, encoder and Yankee 1 absolute encoder



Yankee 1 absolute encoder



The data and the products illustrated in this brochure may be modified without notice. Under no circumstances can their description have a contractual value.



TER Tecno Elettrica Ravasi srl





Via Garibaldi 29/31 - 23885 Calco (LC) - Italy

Registered Office - via San Vigilio 2 - 23887 Olgiate Molgora (LC) - Italy

Tel. +39 0399911011 - Fax +39 0399910445 - E-mail: info@terworld.com

www.terworld.com

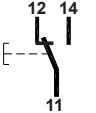
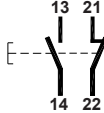
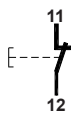
TECHNICAL SPECIFICATIONS OF THE MICROSWITCHES

Code	PRSL0100XX	PRSL0110XX	PRSL0111XX
Utilisation category	AC 15 DC13	AC 15	
Rated operational voltage	125 V / AC 15 230 V / AC 15 60 V / DC 13	250 V	
Rated operational current	2 A / 125 V / AC 15 1 A / 230 V / AC 15 0,5 A / 60 V / DC 13	3 A	
Rated thermal current	6 A	10 A	
Rated insulation voltage	250 V~	300 V~	
Mechanical life	1,5x10 ⁶ operations	1x10 ⁶ operations	
Terminal referencing	According to EN 50013	According to EN 50013	
Connections	screw-type terminals with self-lifting pads	screw-type terminals with self-lifting pads	
Wires	0,25 mm ² - 1,5 mm ²	1x2.5 mm ² , 2x1.5 mm ² (UL: copper conductor (CU) 60°C or 75°C with soft or stiff wire 14-16 AWG)	
Tightening torque	0,5 Nm - 0,6 Nm	0,5 Nm	
Switch type	Single break, snap action	Double break, snap action	Double break, slow action
Contacts	1NO + 1NC change over (All NC contacts are of the positive opening operation type )	1NO + 1NC change over (All NC contacts are of the positive opening operation type )	1NC (All NC contacts are of the positive opening operation type )
Scheme			
Markings and homologations	 (general purpose)		

TECHNICAL SPECIFICATIONS OF THE POTENTIOMETERS

Code with support	PA020001	PA020002
Ohmic value	10 kΩ	10 kΩ mechanical stop
Resolution	Infinite	
Independent linearity	± 1%	
Life time	10x10 ⁶ movements	
Operational ambient temperature	-55°C / +105°C	
Continuous rotation (without stop)	360°	
Continuous rotation (with stop)	333° ± 5°	
Actual electrical angle	310° ± 5°	
Ohmic value tolerance	± 20%	

Code with support	PA020003	PA020004	PA020005
Ohmic value	10 kΩ	10 kΩ	5 kΩ
Connections	4 turrets	3 turrets	4 turrets
Independent linearity (over AEA -3°)	≤ ± 1 %	≤ ± 0,35 %	≤ ± 1 %
Life time	5x10 ⁶ movements		
Operational ambient temperature	-55°C / +125°C		
Mechanical angle	360° continuous		
Actual Electrical Angle (AEA)	340° ± 5°		
Ohmic value tolerance	max ± 20 % at 20°C	max ± 10 % at 20°C	max ± 20 % at 20°C

Code with support	PA020006	PA020007	PA020008
Ohmic value	4.7 kΩ	10 kΩ	2.2 kΩ
Independant linearity	± 0.25%		
Life time	3 000 000 movements		
Operational ambient temperature	-55°C / +125°C		
Mechanical angle	360° continuous		
Actual electrical angle	355°±5°		
Ohmic value tolerance	± 5%		
Temperature drift	< 50 PPM/°C		

Code with support	PA020009
Ohmic value	2 kΩ
Resolution	better then 0.008°
Linearity	±0.075%
Independant linearity	±0.075 %
Life time	100x10 ⁶ movements
Operational ambient temperature	-40°C / +100°C
Mechanical angle	360° continuous
Actual electrical travel	350° ±2°
Ohmic value tolerance	±20%

TECHNICAL SPECIFICATIONS OF THE ENCODERS

Code with support	PA030001	PA030002
Resolution	36 pulses/rev.	150 pulses/rev.
Operational ambient temperature	-40°C / +85°C	
Code	Incremental	
Supply voltage	4,5 Vdc min. to 30 Vdc max. (35 mA max. - no load)	
Output voltage	Low: 500 mV max. at 10 mA High: (Vin - 0,6) at -10 mA (Vin - 1,3) at -25 mA	
Output current	25 mA max. load per output channel	
Output format	Two channel (A, B) quadrature with Index (Z)	
Phase sense	A leads B clockwise (CW) from the mounting end of the encoder	
Accuracy	+/- 0,8 arc-min.	
Outputs	Push pull	
Electrical protection	Reverse polarity and output short circuit protected	

TECHNICAL SPECIFICATIONS OF THE ABSOLUTE ENCODER YANKEE 1

Code	PA01AA01	PA01AB01	PA01AC01
Analog Output	Current 4+20mA	Voltage 0+10V	PWM 0+100%
Operational ambient temperature	-40°C / +80°C		
Power supply	12 ÷ 48 VDC / 12 ÷ 48 Vac		
Protection against polarity inversion	yes		
Absorption	50 mA		
Resolution	12 bit		
Linearity	+/- 0,5°		
Max. hysteresis	0,1°		
Setting Zero Point	through button/wire		
Signal increment direction	CW (standard) / CCW (on request)		
Connections	terminal board		

The data and the products illustrated in this brochure may be modified without notice. Under no circumstances can their description have a contractual value.



TER Tecno Elettrica Ravasi srl

Via Garibaldi 29/31 - 23885 Calco (LC) - Italy

Registered Office - via San Vigilio 2 - 23887 Olgiate Molgora (LC) - Italy

Tel. +39 0399911011 - Fax +39 0399910445 - E-mail: info@terworld.com

www.terworld.com

OVERALL DIMENSIONS (MM)

STANDARD

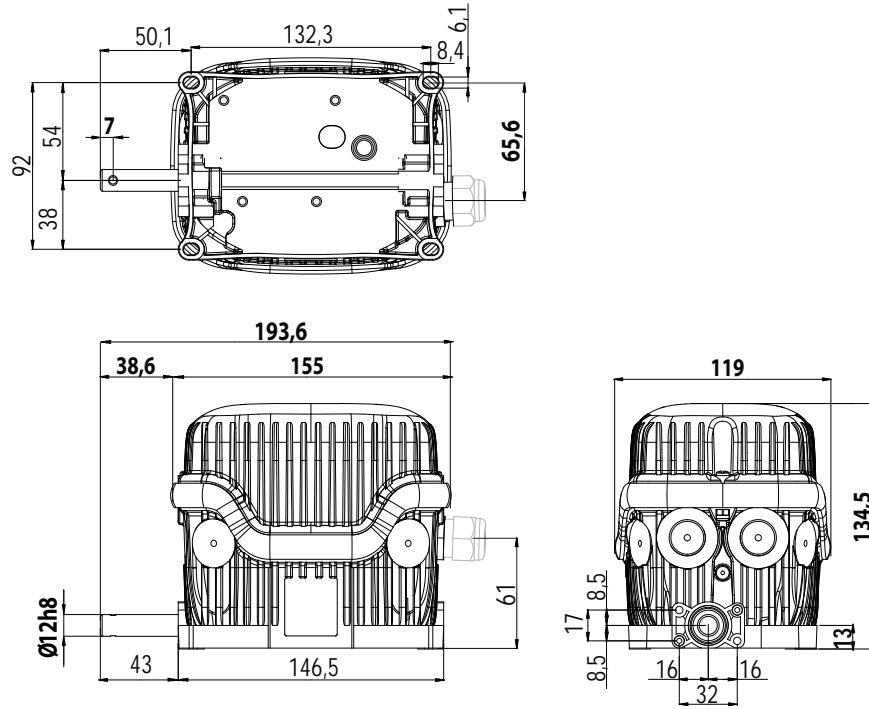

WITH FLANGE

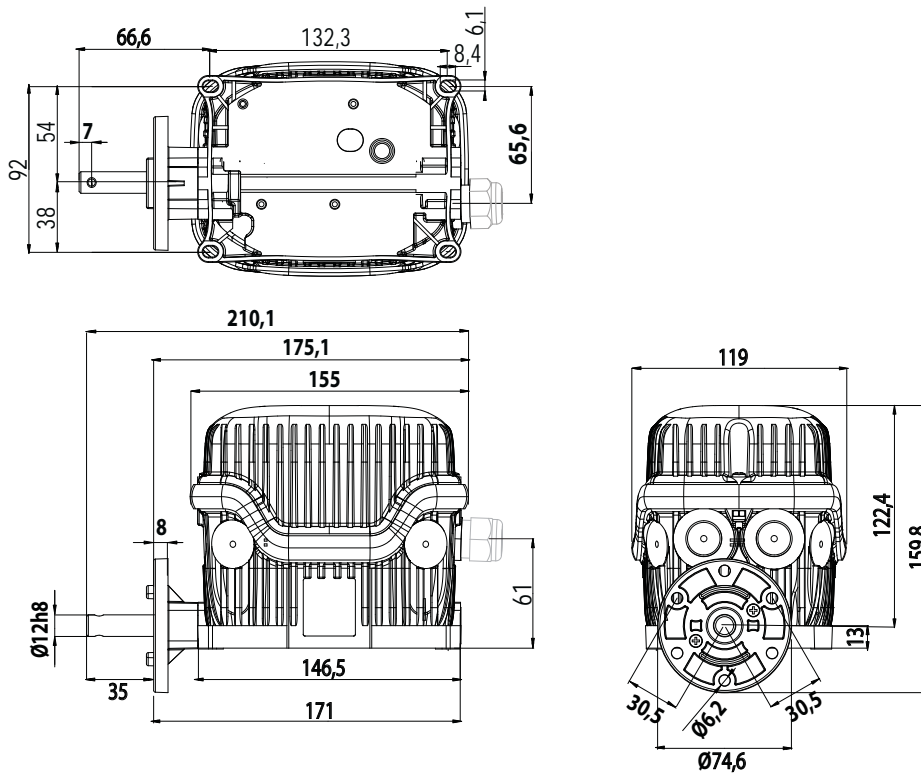

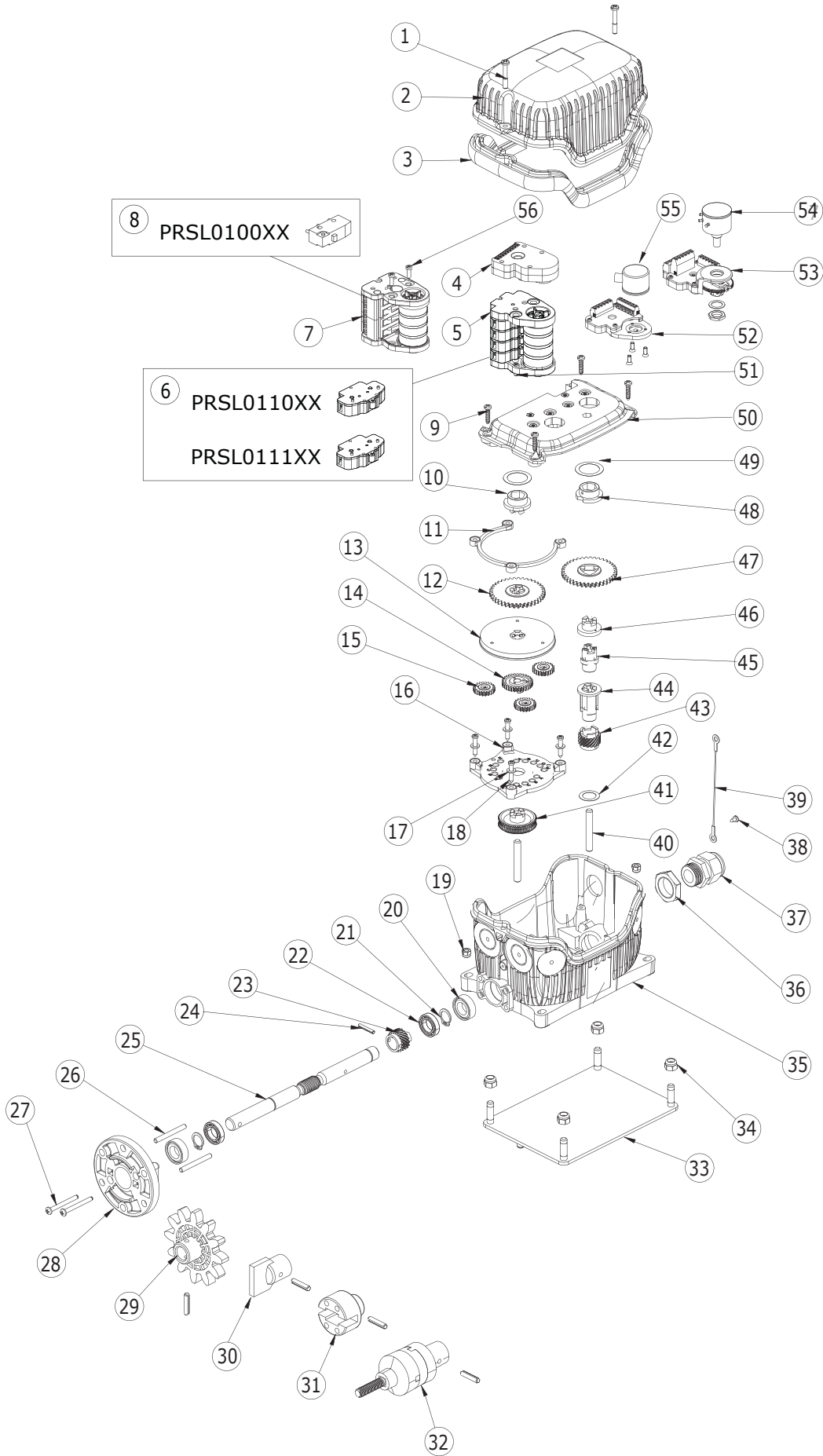

The data and the products illustrated in this brochure may be modified without notice. Under no circumstances can their description have a contractual value.



TER Tecno Elettrica Ravasi srl
 Via Garibaldi 29/31 - 23885 Calco (LC) - Italy
 Registered Office - via San Vigilio 2 - 23887 Olgiate Molgora (LC) - Italy
 Tel. +39 0399911011 - Fax +39 0399910445 - E-mail: info@terworld.com

www.terworld.com

COMPONENTS



SWITCHES

REF	DRAWING	DESCRIPTION	SCHEME	CODE
6		1NO+1NC switch double break, snap action		PRSL0110XX
		1NC switch double break, slow action		PRSL0111XX
8		1NO+1NC switch single break, snap action		PRSL0100XX





STANDARD CAM SETS

REF	DRAWING	NO. AND TYPE OF CAMS	NO. AND TYPE OF SWITCH	SET CODE
5		2 cams D	2 PRSL0110XX switches	FCL20001
		2 cams D	2 PRSL0111XX switches	FCL20002
		Cams D+E	2 PRSL0110XX switches	FCL20003
		Cams D+E	2 PRSL0111XX switches	FCL20004
		2 cams E	2 PRSL0110XX switches	FCL20005
		2 cams E	2 PRSL0111XX switches	FCL20006
		Cams F + F + C + B	4 PRSL0110XX switches	FCL40001
		Cams F + F + C + B	4 PRSL0111XX switches	FCL40002
		4 cams D	4 PRSL0110XX switches	FCL40003
		4 cams D	4 PRSL0111XX switches	FCL40004
		Cams D + D + E + E	4 PRSL0110XX switches	FCL40005
		Cams D + D + E + E	4 PRSL0111XX switches	FCL40006
		4 cams E	4 PRSL0110XX switches	FCL40007
		4 cams E	4 PRSL0111XX switches	FCL40008
7		Cams E + E + E + A	4 PRSL0110XX switches	FCL40009
		Cams E + E + E + A	4 PRSL0111XX switches	FCL40010
		Cams D + D + A + A	4 PRSL0110XX switches	FCL40011
		Cams D + D + A + A	4 PRSL0111XX switches	FCL40012
		2 cams D	2 PRSL0100XX switches	FCN20001
		Cams D+E	2 PRSL0100XX switches	FCN20002
		2 cams E	2 PRSL0100XX switches	FCN20003
		Cams F + F + C + B	4 PRSL0100XX switches	FCN40001
		4 cams D	4 PRSL0100XX switches	FCN40002
		Cams D + D + E + E	4 PRSL0100XX switches	FCN40003
	4 cams E	4 PRSL0100XX switches	FCN40004	
	Cams E + E + E + A	4 PRSL0100XX switches	FCN40005	
	Cams D + D + A + A	4 PRSL0100XX switches	FCN40006	

Other sets with 2-3-4-5 or 6 cams/switches available on request.
PRSLSL0100XX only for 2 or 4 cam sets.

CAM REFERENCE CHART								
CAM	MECHANICAL ANGLE	CODE FOR PRSL0110XX PRSL0111XX SWITCHES	CODE FOR PRSL0100XX SWITCHES	CAM	MECHANICAL ANGLE	CODE FOR PRSL0110XX PRSL0111XX SWITCHES	CODE FOR PRSL0100XX SWITCHES	
A		180°	PRSL7191PI	PRSL7121PI	D	-	PRSL7194PI	PRSL7124PI
B		320°	PRSL7192PI	PRSL7122PI	E	60°	PRSL7195PI	PRSL7125PI
C		-	PRSL7193PI	PRSL7123PI	F	72°	PRSL7196PI	PRSL7126PI

SENSORS, POTENTIOMETERS AND ENCODERS

REF	DRAWING	DESCRIPTION	CODE
4		Yankee 1 - current output	PA01AA01
		Yankee 1 - voltage output	PA01AB01
		Yankee 1 - PWM output	PA01AC01
54+53		Potentiometer MCB 10 kΩ with support	PA020001
		Potentiometer MCB 10 kΩ mechanical stop with support	PA020002
		Potentiometer Sfernice 10 kΩ ±10% 4 pins with support	PA020003
		Potentiometer Sfernice 10 kΩ ±10% 3 pins with support	PA020004
		Potentiometer Sfernice 5 kΩ ±10% with support	PA020005
		Potentiometer Megatron 4.7 kΩ with support	PA020006
		Potentiometer Megatron 10 kΩ with support	PA020007
		Potentiometer Megatron 2.2 kΩ with support	PA020008
		Potentiometer Novoteknik 2KΩ with support	PA020009
53		Support for potentiometer	PA020000
55+52		Encoder 36 pulses./rev. with support	PA030001
		Encoder 150 pulses./rev. with support	PA030002
52		Support for encoder	PA030000

PINION GEARS

REF	DRAWING	DESCRIPTION	CODE
29		Pinion gear M10 Z12 with pin	PRSL0911PI
		Pinion gear M12 Z10 with pin	PRSL0912PI
		Pinion gear M14 Z10 with pin	PRSL0913PI
		Pinion gear M16 Z10 with pin	PRSL0914PI
		Pinion gear M20 Z8 with pin	PRSL0915PI
		Pinion gear M5 Z12 with pin	PRSL0916PI
		Pinion gear M6 Z11 with pin	PRSL0917PI
		Pinion gear M8 Z12 with pin	PRSL0918PI
		Pinion gear M12 Z12 with pin	PRSL0944PI

Other pinion gears available: see "Gears and pinion gears" catalog

The data and the products illustrated in this brochure may be modified without notice. Under no circumstances can their description have a contractual value.



TER Tecno Elettrica Ravasi srl







Via Garibaldi 29/31 - 23885 Calco (LC) - Italy

Registered Office - via San Vigilio 2 - 23887 Olgiate Molgora (LC) - Italy

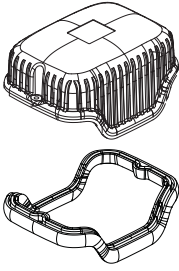
Tel. +39 0399911011 - Fax +39 0399910445 - E-mail: info@terworld.com

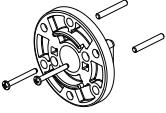
www.terworld.com

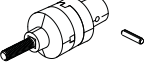
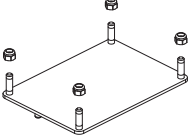

ACCESSORIES

REF	DRAWING	DESCRIPTION	CODE
2+3		Cover with tightening rubber	PA090008
39		Cover holding wire	PRVV9140PE
28+27+26		Flange with screws and pins	PRSL0356PI
30		Male coupling with pin	PRSL0919PI
31		Female coupling with pin	PRSL0920PI
32		Coupling with pin	PRSL0981PI
33+34		Fixing plate	PRSL0725PI
37		Cable clamp M16	PRPS0062PE
		Cable clamp M20x1.5	PRPS0063PE

REMARKS

STANDARD LIMIT SWITCHES

All standard limit switches are equipped with cams PRSL7194PI  for PRSL0110XX and PRSL0111XX switches, PRSL7124PI  for PRSL0100XX switches and shafts made of stainless steel AISI 430F.

OUTPUT 1 RATED REVOLUTION RATIO	REAL REVOLUTION RATIO	OUTPUT 2 RATED REVOLUTION RATIO	NO. CAMS AND SWITCHES	SWITCHES		
				PRSL0100XX	PRSL0110XX	PRSL0111XX
				 1 NO + 1 NC	 1 NO + 1 NC	 1 NC
				CODE	CODE	CODE
1 : 1	1 : 1	1 : 1	2	PFC9067A0001001	PFC9067L0001007	PFC9067L0001013
		1 : 1	4	PFC9067A0001002	PFC9067L0001008	PFC9067L0001012
		1 : 1	4 + 2	PFC9067A0001003	PFC9067L0001010	PFC9067L0001014
		1 : 1	4 + 4	PFC9067A0001004	PFC9067L0001011	PFC9067L0001015
1 : 5	1 : 8,16	1 : 5	2	PFC9067A0008002	PFC9067L0008004	PFC9067L0008009
		1 : 1	2	PFC9067A0008005	PFC9067L0008005	PFC9067L0008010
		1 : 5	4	PFC9067A0008001	PFC9067L0008003	PFC9067L0008011
		1 : 1	4	PFC9067A0008006	PFC9067L0008006	PFC9067L0008012
		1 : 5	4 + 2	PFC9067A0008003	PFC9067L0008007	PFC9067L0008013
		1 : 5	4 + 4	PFC9067A0008004	PFC9067L0008008	PFC9067L0008014
1 : 10	1 : 10,60	1 : 10	2	PFC9067A0010003	PFC9067L0010007	PFC9067L0010012
		1 : 1	2	PFC9067A0010007	PFC9067L0010008	PFC9067L0010013
		1 : 10	4	PFC9067A0010004	PFC9067L0010006	PFC9067L0010014
		1 : 1	4	PFC9067A0010008	PFC9067L0010009	PFC9067L0010015
		1 : 10	4 + 2	PFC9067A0010005	PFC9067L0010010	PFC9067L0010016
		1 : 10	4 + 4	PFC9067A0010006	PFC9067L0010011	PFC9067L0010017
1 : 15	1 : 15,50	1 : 15	2	PFC9067A0015001	PFC9067L0015004	PFC9067L0015010
		1 : 1	2	PFC9067A0015005	PFC9067L0015005	PFC9067L0015011
		1 : 15	4	PFC9067A0015002	PFC9067L0015006	PFC9067L0015012
		1 : 1	4	PFC9067A0015006	PFC9067L0015007	PFC9067L0015013
		1 : 15	4 + 2	PFC9067A0015003	PFC9067L0015008	PFC9067L0015014
		1 : 15	4 + 4	PFC9067A0015004	PFC9067L0015009	PFC9067L0015015
1 : 20	1 : 21,20	1 : 20	2	PFC9067A0021001	PFC9067L0021003	PFC9067L0021009
		1 : 1	2	PFC9067A0021005	PFC9067L0021004	PFC9067L0021010
		1 : 20	4	PFC9067A0021002	PFC9067L0021005	PFC9067L0021011
		1 : 1	4	PFC9067A0021006	PFC9067L0021006	PFC9067L0021012
		1 : 20	4 + 2	PFC9067A0021003	PFC9067L0021007	PFC9067L0021013
		1 : 20	4 + 4	PFC9067A0021004	PFC9067L0021008	PFC9067L0021014
1 : 25	1 : 26,10	1 : 25	2	PFC9067A0026002	PFC9067L0026005	PFC9067L0026013
		1 : 1	2	PFC9067A0026006	PFC9067L0026006	PFC9067L0026014
		1 : 25	4	PFC9067A0026003	PFC9067L0026007	PFC9067L0026015
		1 : 1	4	PFC9067A0026007	PFC9067L0026008	PFC9067L0026016
		1 : 25	4 + 2	PFC9067A0026004	PFC9067L0026009	PFC9067L0026017
		1 : 25	4 + 4	PFC9067A0026005	PFC9067L0026010	PFC9067L0026018
1 : 50	1 : 62	1 : 50	2	PFC9067A0062002	PFC9067L0062004	PFC9067L0062014
		1 : 1	2	PFC9067A0062006	PFC9067L0062012	PFC9067L0062015
		1 : 50	4	PFC9067A0062003	PFC9067L0062005	PFC9067L0062016
		1 : 1	4	PFC9067A0062007	PFC9067L0062013	PFC9067L0062017
		1 : 50	4 + 2	PFC9067A0062004	PFC9067L0062006	PFC9067L0062021
		1 : 50	4 + 4	PFC9067A0062005	PFC9067L0062007	PFC9067L0062022

The data and the products illustrated in this brochure may be modified without notice. Under no circumstances can their description have a contractual value.





TER Tecno Elettrica Ravasi srl

Via Garibaldi 29/31 - 23885 Calco (LC) - Italy

Registered Office - via San Vigilio 2 - 23887 Olgiate Molgora (LC) - Italy

Tel. +39 0399911011 - Fax +39 0399910445 - E-mail: info@terworld.com

www.terworld.com

OUTPUT 1 RATED REVOLUTION RATIO	REAL REVOLUTION RATIO	OUTPUT 2 RATED REVOLUTION RATIO	NO. CAMS AND SWITCHES	SWITCHES		
				PRSL0100XX	PRSL0110XX	PRSL0111XX
						
1 NO + 1 NC	1 NO + 1 NC	1 NC				
				CODE	CODE	CODE
1:70	1 : 73,63	1 : 70	2	PFC9067A0073001	PFC9067L0073004	PFC9067L0073009
		1 : 1	2	PFC9067A0073005	PFC9067L0073005	PFC9067L0073010
		1 : 70	4	PFC9067A0073002	PFC9067L0073003	PFC9067L0073011
		1 : 1	4	PFC9067A0073006	PFC9067L0073006	PFC9067L0073012
		1 : 70	4 + 2	PFC9067A0073003	PFC9067L0073007	PFC9067L0073013
		1 : 70	4 + 4	PFC9067A0073004	PFC9067L0073008	PFC9067L0073014
1:100	1 : 107	1 : 100	2	PFC9067A0107007	PFC9067L0107014	PFC9067L0107025
		1 : 1	2	PFC9067A0107011	PFC9067L0107019	PFC9067L0107026
		1 : 100	4	PFC9067A0107008	PFC9067L0107015	PFC9067L0107004
		1 : 1	4	PFC9067A0107012	PFC9067L0107020	PFC9067L0107018
		1 : 100	4 + 2	PFC9067A0107009	PFC9067L0107016	PFC9067L0107027
		1 : 100	4 + 4	PFC9067A0107010	PFC9067L0107017	PFC9067L0107028
1:150	1 : 156,50	1 : 150	2	PFC9067A0156002	PFC9067L0156004	PFC9067L0156011
		1 : 1	2	PFC9067A0156003	PFC9067L0156007	PFC9067L0156012
		1 : 150	4	PFC9067A0156004	PFC9067L0156005	PFC9067L0156013
		1 : 1	4	PFC9067A0156007	PFC9067L0156008	PFC9067L0156014
		1 : 150	4 + 2	PFC9067A0156005	PFC9067L0156006	PFC9067L0156015
		1 : 150	4 + 4	PFC9067A0156006	PFC9067L0156009	PFC9067L0156016
1 : 200	1 : 214,20	1 : 200	2	PFC9067A0214006	PFC9067L0214004	PFC9067L0214010
		1 : 1	2	PFC9067A0214004	PFC9067L0214006	PFC9067L0214011
		1 : 200	4	PFC9067A0214001	PFC9067L0214005	PFC9067L0214002
		1 : 1	4	PFC9067A0214005	PFC9067L0214007	PFC9067L0214012
		1 : 200	4 + 2	PFC9067A0214007	PFC9067L0214008	PFC9067L0214013
		1 : 200	4 + 4	PFC9067A0214008	PFC9067L0214009	PFC9067L0214014
1 : 250	1 : 254,30	1 : 250	2	PFC9067A0254002	PFC9067L0254004	PFC9067L0254014
		1 : 1	2	PFC9067A0254006	PFC9067L0254007	PFC9067L0254015
		1 : 250	4	PFC9067A0254003	PFC9067L0254005	PFC9067L0254016
		1 : 1	4	PFC9067A0254007	PFC9067L0254008	PFC9067L0254017
		1 : 250	4 + 2	PFC9067A0254004	PFC9067L0254009	PFC9067L0254018
		1 : 250	4 + 4	PFC9067A0254005	PFC9067L0254010	PFC9067L0254019
1 : 300	1 : 313	1 : 300	2	PFC9067A0313003	PFC9067L0313023	PFC9067L0313030
		1 : 1	2	PFC9067A0313007	PFC9067L0313025	PFC9067L0313031
		1 : 300	4	PFC9067A0313004	PFC9067L0313024	PFC9067L0313032
		1 : 1	4	PFC9067A0313008	PFC9067L0313026	PFC9067L0313033
		1 : 300	4 + 2	PFC9067A0313005	PFC9067L0313027	PFC9067L0313034
		1 : 300	4 + 4	PFC9067A0313006	PFC9067L0313028	PFC9067L0313035
1 : 450	1 : 471,20	1 : 450	2	PFC9067A0471002	PFC9067L0471002	PFC9067L0471008
		1 : 1	2	PFC9067A0471006	PFC9067L0471003	PFC9067L0471009
		1 : 450	4	PFC9067A0471003	PFC9067L0471004	PFC9067L0471001
		1 : 1	4	PFC9067A0471007	PFC9067L0471005	PFC9067L0471010
		1 : 450	4 + 2	PFC9067A0471004	PFC9067L0471006	PFC9067L0471011
		1 : 450	4 + 4	PFC9067A0471005	PFC9067L0471007	PFC9067L0471012

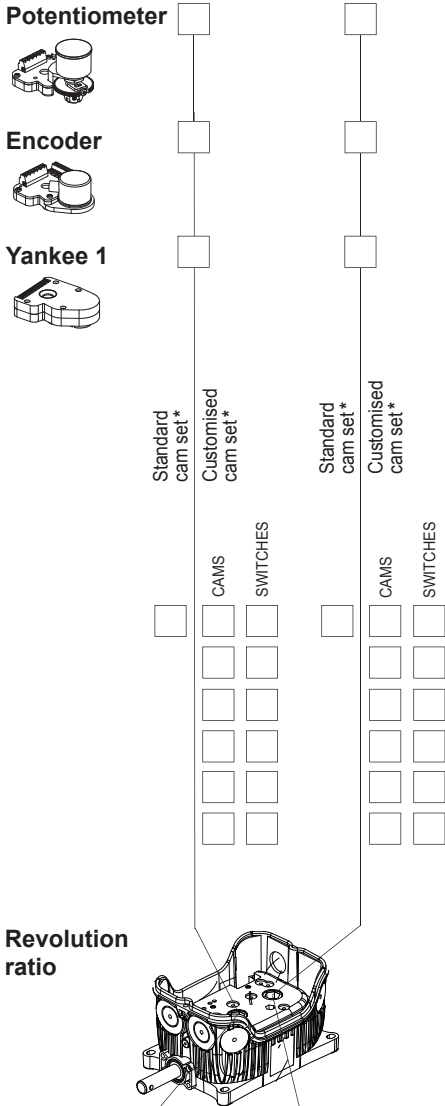

- Revolution ratio**
- 1:1 1:70 1:1
- 1:5 1:100 Revolution ratio equal to output 1
- 1:10 1:150
- 1:15 1:200
- 1:20 1:250
- 1:25 1:300
- 1:50 1:450
- 1:

* Mark the number corresponding to the cam set required, if standard; otherwise mark the letters corresponding to the single cams and switches required. PRSLSL0100XX only for 2 or 4 cam sets.

- Encoder**
- R PA030001 T PA01AA01
- S PA030002 U PA01AB01
- V PA01AC01
- * Programmable

- Potentiometer**
- G PA020001 N PA020006
- H PA020002 O PA020007
- I PA020003 P PA020008
- L PA020004 Q PA020009
- M PA020005

Standard cam sets

		Switches		
		PRSL0100XX	PRSL0110XX	PRSL0111XX
Cams				
<input type="checkbox"/> D	<input type="checkbox"/> D	<input type="checkbox"/> 1	<input type="checkbox"/> 11	<input type="checkbox"/> 21
<input type="checkbox"/> D	<input type="checkbox"/> E	<input type="checkbox"/> 2	<input type="checkbox"/> 12	<input type="checkbox"/> 22
<input type="checkbox"/> E	<input type="checkbox"/> E	<input type="checkbox"/> 3	<input type="checkbox"/> 13	<input type="checkbox"/> 23
<input type="checkbox"/> F	<input type="checkbox"/> F <input type="checkbox"/> C <input type="checkbox"/> B	<input type="checkbox"/> 4	<input type="checkbox"/> 14	<input type="checkbox"/> 24
<input type="checkbox"/> D	<input type="checkbox"/> D <input type="checkbox"/> D <input type="checkbox"/> D	<input type="checkbox"/> 5	<input type="checkbox"/> 15	<input type="checkbox"/> 25
<input type="checkbox"/> D	<input type="checkbox"/> D <input type="checkbox"/> E <input type="checkbox"/> E	<input type="checkbox"/> 6	<input type="checkbox"/> 16	<input type="checkbox"/> 26
<input type="checkbox"/> E	<input type="checkbox"/> E <input type="checkbox"/> E <input type="checkbox"/> E	<input type="checkbox"/> 7	<input type="checkbox"/> 17	<input type="checkbox"/> 27
<input type="checkbox"/> E	<input type="checkbox"/> E <input type="checkbox"/> E <input type="checkbox"/> A	<input type="checkbox"/> 8	<input type="checkbox"/> 18	<input type="checkbox"/> 28
<input type="checkbox"/> D	<input type="checkbox"/> D <input type="checkbox"/> A <input type="checkbox"/> A	<input type="checkbox"/> 9	<input type="checkbox"/> 19	<input type="checkbox"/> 29

Cams

		Codes for PRSL0110XX PRSL0111XX switches	Codes for PRSL0100XX switches
<input type="checkbox"/> A	(180°)	PRSL7191PI	PRSL7121PI
<input type="checkbox"/> B	(320°)	PRSL7192PI	PRSL7122PI
<input type="checkbox"/> C		PRSL7193PI	PRSL7123PI
<input type="checkbox"/> D		PRSL7194PI	PRSL7124PI
<input type="checkbox"/> E	(60°)	PRSL7195PI	PRSL7125PI
<input type="checkbox"/> F	(72°)	PRSL7196PI	PRSL7126PI

(Degrees correspond to mechanical angle)

- Switches**
- X PRSL0100XX
- Y PRSL0110XX
- Z PRSL0111XX

Male coupling

Female coupling

Coupling

Flange

Pinion gear

- PRSL0911PI M10 Z12
- PRSL0912PI M12 Z10
- PRSL0913PI M14 Z10
- PRSL0914PI M16 Z10
- PRSL0915PI M20 Z8
- PRSL0916PI M5 Z12
- PRSL0917PI M6 Z11
- PRSL0918PI M8 Z12
- PRSL0944PI M12 Z12
- Customised M Z

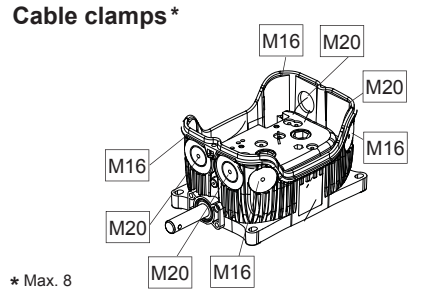

Shaft

Shaft made of stainless steel AISI 430F

Shaft made of high resistance stainless steel AISI 303

SIL1 version

The data and the products illustrated in this brochure may be modified without notice. Under no circumstances can their description have a contractual value.



TER Tecno Elettrica Ravasi srl
 Via Garibaldi 29/31 - 23885 Calco (LC) - Italy
 Registered Office - via San Vigilio 2 - 23887 Olgiate Molgora (LC) - Italy
 Tel. +39 0399911011 - Fax +39 0399910445 - E-mail: info@terworld.com

www.terworld.com

Oscar rotary limit switch is an electromechanical device for low voltage control circuits (EN 60947-1, EN 60947-5-1) to be used as electrical equipment on machines (EN 60204-1) in compliance with the fundamental requirements of the Low Voltage Directive 2006/95/CE and of the Machine Directive 2006/42/CE.

The limit switch is designed for use in industrial environments under even severe climatic conditions (operational temperature from -40°C to $+80^{\circ}\text{C}$, suitable for use in tropical environment). The equipment is not suitable for use in environments with potentially explosive atmosphere, corrosive agents or a high percentage of sodium chloride (saline fog). Oils, acids or solvents may damage the equipment; avoid using them for cleaning. Do not connect more than one phase to each switch. Do not oil or grease the control elements or the switches.

The limit switch is supplied with a bag of accessories including: 2 self-locking nuts (3), 2 metric screws (1), 1 no-drop wire (8), 1 self-tapping screw (0).

The installation of the limit switch shall be carried out by expert and trained personnel. Wiring shall be properly done according to the current instructions.

Prior to the installation and the maintenance of the limit switch, the main power of the machinery shall be turned off.

Steps for the proper installation of the limit switch

- place the self-locking nuts (3) in their seats on the enclosure (4)
- insert one end of the no-drop wire (8) into the self-tapping screw (9) and tighten the screw into its hole on the enclosure (4)
- connect the limit switch shaft (5) to the reduction gear shaft; avoid any misalignment between the two shafts
- fix the limit switch firmly in place to prevent abnormal vibrations of the equipment during operation; use only the fixing holes (6) on the base (04) to fix the equipment
- insert the cable into the limit switch through the cable clamp (7)
- strip the multipole cable to a length suitable for stripping the single poles; we suggest the use of pin terminals
- clamp the wire into the cable clamp (7)
- when PRSL0110XX and PRSL0111XX switches are used connect the switches according to the contact scheme printed on the switches or to the wiring scheme on the back of the instructions (tighten the wires into the terminals with a torque equal to 0.5 Nm; (UL (c)UL: use 60°C or 75°C copper (CU) conductors and stiff or flexible wire 14-16 AWG); insertability of wires into the terminals $2 \times 0.5 \text{ mm}^2$ $2 \times 1.5 \text{ mm}^2$ $1 \times 2.5 \text{ mm}^2$)
- when PRSL0100XX switches are used connect the terminals according to the contact scheme printed on the label placed on the cam set (tighten the wires to the terminals with a torque of 50/60 cNm; insertability of wires into the terminals $0.25/1.5 \text{ mm}^2$)
- adjust the operating point of the cams; for proper adjustment, loosen the central screw (12) of the cam set, adjust the operating point of each single cam by turning its screw (11) (the numbers on the screws refer to the cams counting from bottom to top of the set), then tighten the central screw (12)
- insert the free end of the no-drop wire (8) into one metric screw, then close the limit switch using the metric screws (1); check the proper positioning of the rubber in the cover (2) and tighten the screws (1) with a torque of 80/100 cNm

Steps for routine maintenance

- check the proper tightening of the screws (1) and cover (2)
- check the proper tightening of the central screw (12) holding the cams
- check the wiring conditions (in particular where wires clamp into the terminals)
- check the conditions of the rubber fit into the cover (2) and check the tightening of the cable clamp (7) around the cable
- check that the limit switch enclosure (2, 4) is not broken
- check the alignment between the limit switch shaft (5) and the reduction gear shaft
- check that the limit switch is properly fixed
- if there is an anti-moisture plug, check its conditions

In case any component of the limit switch is modified, the validity of the markings and the guarantee on the equipment are annulled. Should any component need replacement, use original spare parts only.

TER declines all responsibility for damages caused by the improper use or installation of the equipment.

Technical Specifications UL with PRSL0110XX and PRSL0111XX switches

Code Oscar certified UL = PFC9U67L XXXX XXX

= PFC9U67M XXXX XXX

Contact Blocks Rating = A600, Q600

Cord diameter range = 0.51 in (13mm)

Cord type = flexible, type minimum S or SJ (ZJCZ/7)

Wire size range = 14-16 AWG stranded or solid

Conductors = Copper (CU) $60/75^{\circ}\text{C}$

Terminal tightening torque = 4.50 lb.in (0.5Nm)

Marking = ms

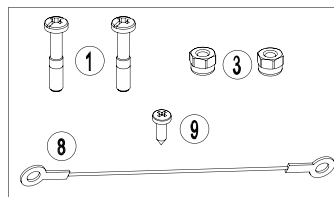
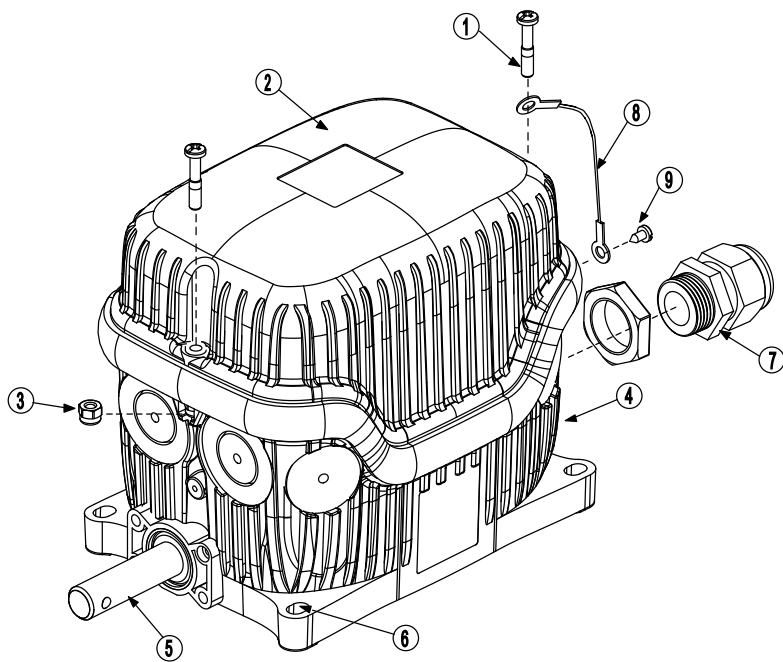

Accessory bag

Cam set with PRSL0110XX or PRSL0111XX switches

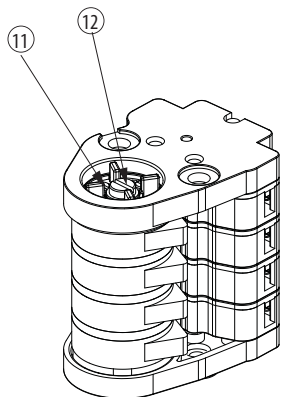

Cam set with PRSL0100XX switches

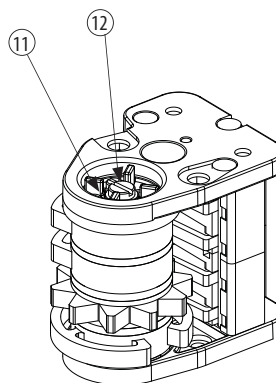

*Image for illustrative purpose
the number and type of cams is different according to the model*

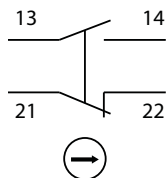

Wiring Layout Switches PRSL0110XX

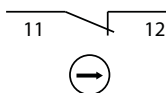

Wiring Layout Switches PRSL0111XX

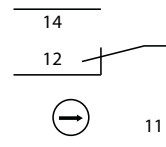

Wiring Layout Switches PRSL0100XX

The data and the products illustrated in this brochure may be modified without notice. Under no circumstances can their description have a contractual value.



TER Tecno Elettrica Ravasi srl

Via Garibaldi 29/31 - 23885 Calco (LC) - Italy

Registered Office - via San Vigilio 2 - 23887 Olgiate Molgora (LC) - Italy

Tel. +39 0399911011 - Fax +39 0399910445 - E-mail: info@terworld.com

www.terworld.com