



TOP

ROTARY LIMIT SWITCH

Top is a rotary limit switch used to control the movement of industrial machinery. It operates as an auxiliary controller of electrical motors through a power interface, such as a contactor or PLC. Suitable for heavy duty, its shaft is connected to the motor and, after a set number of revolutions, the cams operate the switches, thus starting the predetermined movement. A worm gear and a helical toothed gear combined with one or more pairs of straight toothed gears are used for the transmission of the movement from the input shaft to the output shaft.

Top is used on wind turbines to control the position of the nacelle or the pitch angle of the blades. The motor that controls the rotation of a wind turbine on the yaw axis (or of the blade around its longitudinal axis) transfers the movement to the limit switch. A rotary encoder reads the rotation of the shaft, and its pulses are sent to a PLC which controls the position of the nacelle or of the blade. The movement of the shaft is also transferred, through a gearmotor, to a series of cam switches: the appropriate setting of the actuating point of the cams can signal up to four critical positions of the movement of the nacelle or of the blade.

FEATURES

Revolution ratios, ranging from 1:1 to 1:8100, result from the use of different combinations of gear wheels between the input shaft and the output shaft, which is connected to the cams operating the switches. Each output of the limit

switch can be set with a different revolution ratio to allow for a diversified control of the machinery to meet special requirements.

Each cam can be set with great accuracy thanks to the cam adjusting screws.

The auxiliary switches are of a positive opening type, thus suitable for safety functions.

OPTIONS

Top can be fitted with different combinations of actuators and motion detectors: sets of cams and microswitches (max. 15), potentiometers or encoders (max. 3), absolute encoder Yankee 1 for set of cams and microswitches (max. 3). It is possible to fit together sets of cams and microswitches, potentiometers and encoder, thus creating a device featuring redundancy and diversity.

The limit switch is available with a flange for direct coupling to the motor. Different labels and colors are also available.

MATERIALS

Top features transmission and gear driving shafts made of stainless steel AISI 303, worm gear transmission shaft rotating on ball bearings, self-lubricating techno-polymer gears and driving bushes. The base and the cover of the rotary limit switch are made of electrostatic varnished die-cast aluminum.

Materials and components are wear and saline fog resistant, and protect the equipment against water and dust.



INDUSTRIAL
LIFTING



CONSTRUCTION
LIFTING



INDUSTRIAL
AUTOMATION



STAGE
TECHNOLOGY



WIND
ENERGY

STANDARDS - MARKINGS - HOMOLOGATIONS

Conformity to Community Directives:

2006/95/CE: Low Voltage Directive

2006/42/CE: Machinery Directive

- Conformity to Standards:

EN 60204-1 Safety of machinery - Electrical equipment of machines

EN 60204-32 Safety of machinery - Electrical equipment of machines

- Requirements for hoisting machines

EN 60947-1 Low-voltage switchgear and controlgear

EN 60947-5-1 Low-voltage switchgear and controlgear - Control circuit devices and switching elements - Electromechanical control circuit devices

EN 60529 Degrees of protection provided by enclosures

- Regulations for the prevention of accidents BGV C 1 (only for Germany)

- CAN/CSA-C22.2 No 14-10 - Industrial Control Equipment

- UL 508 - Industrial Control Equipment

GENERAL TECHNICAL SPECIFICATIONS

- Saline fog resistant

- Storage ambient temperature: -40°C/+80°C

- Operational ambient temperature: -40°C/+80°C

- Protection degree: IP 66 / IP 67 / IP 69K

- Insulation category: Class I

- Maximum rotation speed: 800 rev./min.

- Cable entry: cable clamp M20

- Markings and homologations:     SIL 1

TECHNICAL SPECIFICATIONS OF THE MICROSWITCHES

- Utilisation category:

AC 15 / 250 V / 3 A max.

DC 13 / 60 V / 0.5 A max.

- Rated thermal current: 10 A max.

- Rated insulation voltage: 300 Vac



- Mechanical life: 1.5x10⁶ operations max.

- Terminal referencing: according to EN 50013

- Connections: screw-type terminals

- Markings and homologations:

PRSL0100XX:     (general purpose)

PRSL0110XX-PRSL0111XX:   

- The snap action switch PRSL0100XX has 1 NO + 1 NC change over contacts.

- The snap action switch PRSL0110XX has 1 NO + 1 NC change over contacts, double break.

- The slow action switch PRSL0111XX has 1 NC contact, double break.

All NC contacts are of the positive opening operation type . The switches have the following reference for internal wiring.

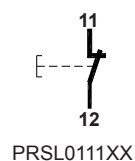
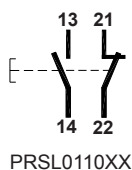
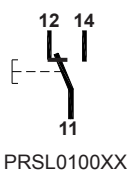

OVERALL DIMENSIONS (MM)

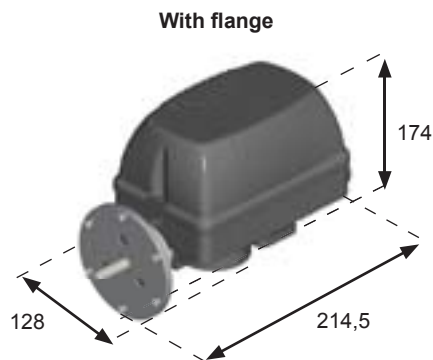
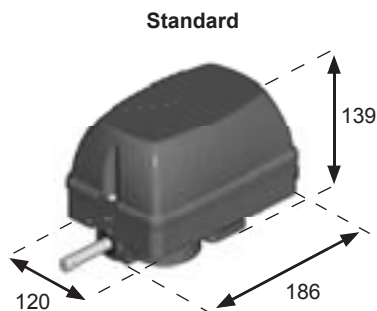

POSSIBLE ASSEMBLIES

With 3 sets of cams



With absolute encoder Yankee 1, encoder and potentiometer



The data and the products illustrated in this brochure may be modified without notice. Under no circumstances can their description have a contractual value.



TER Tecno Elettrica Ravasi srl





Via Garibaldi 29/31 - 23885 Calco (LC) - Italy

Registered Office - via San Vigilio 2 - 23887 Olgiate Molgora (LC) - Italy

Tel. +39 0399911011 - Fax +39 0399910445 - E-mail: info@terworld.com

www.terworld.com

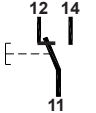
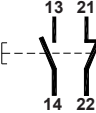
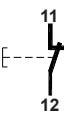
TECHNICAL SPECIFICATIONS OF THE MICROSWITCHES

Code	PRSL0100XX	PRSL0110XX	PRSL0111XX
Utilisation category	AC 15 DC13	AC 15	
Rated operational voltage	125 V / AC 15 230 V / AC 15 60 V / DC 13	250 V	
Rated operational current	2 A / 125 V / AC 15 1 A / 230 V / AC 15 0,5 A / 60 V / DC 13	3 A	
Rated thermal current	6 A	10 A	
Rated insulation voltage	250 V~	300 V~	
Mechanical life	1,5x10 ⁶ operations	1x10 ⁶ operations	
Terminal referencing	According to EN 50013	According to EN 50013	
Connections	screw-type terminals with self-lifting pads	screw-type terminals with self-lifting pads	
Wires	0,25 mm ² - 1,5 mm ²	1x2.5 mm ² , 2x1.5 mm ² (UL: copper conductor (CU) 60°C or 75°C with soft or stiff wire 14-16 AWG)	
Tightening torque	0,5 Nm - 0,6 Nm	0,5 Nm	
Switch type	Single break, snap action	Double break, snap action	Double break, slow action
Contacts	1NO + 1NC change over (All NC contacts are of the positive opening operation type )	1NO + 1NC change over (All NC contacts are of the positive opening operation type )	1NC (All NC contacts are of the positive opening operation type )
Scheme			
Markings and homologations	 (general purpose)		

TECHNICAL SPECIFICATIONS OF THE POTENTIOMETERS

Code with support	PA020001	PA020002
Ohmic value	10 kΩ	10 kΩ mechanical stop
Resolution	Infinite	
Independent linearity	± 1%	
Life time	10x10 ⁶ movements	
Operational ambient temperature	-55°C / +105°C	
Continuous rotation (without stop)	360°	
Continuous rotation (with stop)	333° ± 5°	
Actual electrical angle	310° ± 5°	
Ohmic value tolerance	± 20%	

Code with support	PA020003	PA020004	PA020005
Ohmic value	10 kΩ	10 kΩ	5 kΩ
Connections	4 turrets	3 turrets	4 turrets
Independent linearity (over AEA -3°)	≤ ± 1 %	≤ ± 0,35 %	≤ ± 1 %
Life time	5x10 ⁶ movements		
Operational ambient temperature	-55°C / +125°C		
Mechanical angle	360° continuous		
Actual Electrical Angle (AEA)	340° ± 5°		
Ohmic value tolerance	max ± 20 % at 20°C	max ± 10 % at 20°C	max ± 20 % at 20°C

Code with support	PA020006	PA020007	PA020008
Ohmic value	4.7 kΩ	10 kΩ	2.2 kΩ
Independant linearity	± 0.25%		
Life time	3 000 000 movements		
Operational ambient temperature	-55°C / +125°C		
Mechanical angle	360° continuous		
Actual electrical angle	355°±5°		
Ohmic value tolerance	± 5%		
Temperature drift	< 50 PPM/°C		

Code with support	PA020009
Ohmic value	2 kΩ
Resolution	better then 0.008°
Linearity	±0.075%
Independant linearity	±0.075 %
Life time	100x10 ⁶ movements
Operational ambient temperature	-40°C / +100°C
Mechanical angle	360° continuous
Actual electrical travel	350° ±2°
Ohmic value tolerance	±20%

TECHNICAL SPECIFICATIONS OF THE ENCODERS

Code with support	PA030001	PA030002
Resolution	36 pulses/rev.	150 pulses/rev.
Operational ambient temperature	-40°C / +85°C	
Code	Incremental	
Supply voltage	4,5 Vdc min. to 30 Vdc max. (35 mA max. - no load)	
Output voltage	Low: 500 mV max. at 10 mA High: (Vin - 0,6) at -10 mA (Vin - 1,3) at -25 mA	
Output current	25 mA max. load per output channel	
Output format	Two channel (A, B) quadrature with Index (Z)	
Phase sense	A leads B clockwise (CW) from the mounting end of the encoder	
Accuracy	+/- 0,8 arc-min.	
Outputs	Push pull	
Electrical protection	Reverse polarity and output short circuit protected	

TECHNICAL SPECIFICATIONS OF THE ABSOLUTE ENCODER YANKEE 1

Code	PA01AA01	PA01AB01	PA01AC01
Analog Output	Current 4÷20mA	Voltage 0÷10V	PWM 0÷100%
Operational ambient temperature	-40°C / +80°C		
Power supply	12 ÷ 48 VDC / 12 ÷ 48 Vac		
Protection against polarity inversion	yes		
Absorption	50 mA		
Resolution	12 bit		
Linearity	+/- 0,5°		
Max. hysteresis	0,1°		
Setting Zero Point	through button/wire		
Signal increment direction	CW (standard) / CCW (on request)		
Connections	terminal board		

The data and the products illustrated in this brochure may be modified without notice. Under no circumstances can their description have a contractual value.



TER Tecno Elettrica Ravasi srl

Via Garibaldi 29/31 - 23885 Calco (LC) - Italy
Registered Office - via San Vigilio 2 - 23887 Olgiate Molgora (LC) - Italy
Tel. +39 0399911011 - Fax +39 0399910445 - E-mail: info@terworld.com

www.terworld.com

OVERALL DIMENSIONS (MM)

STANDARD

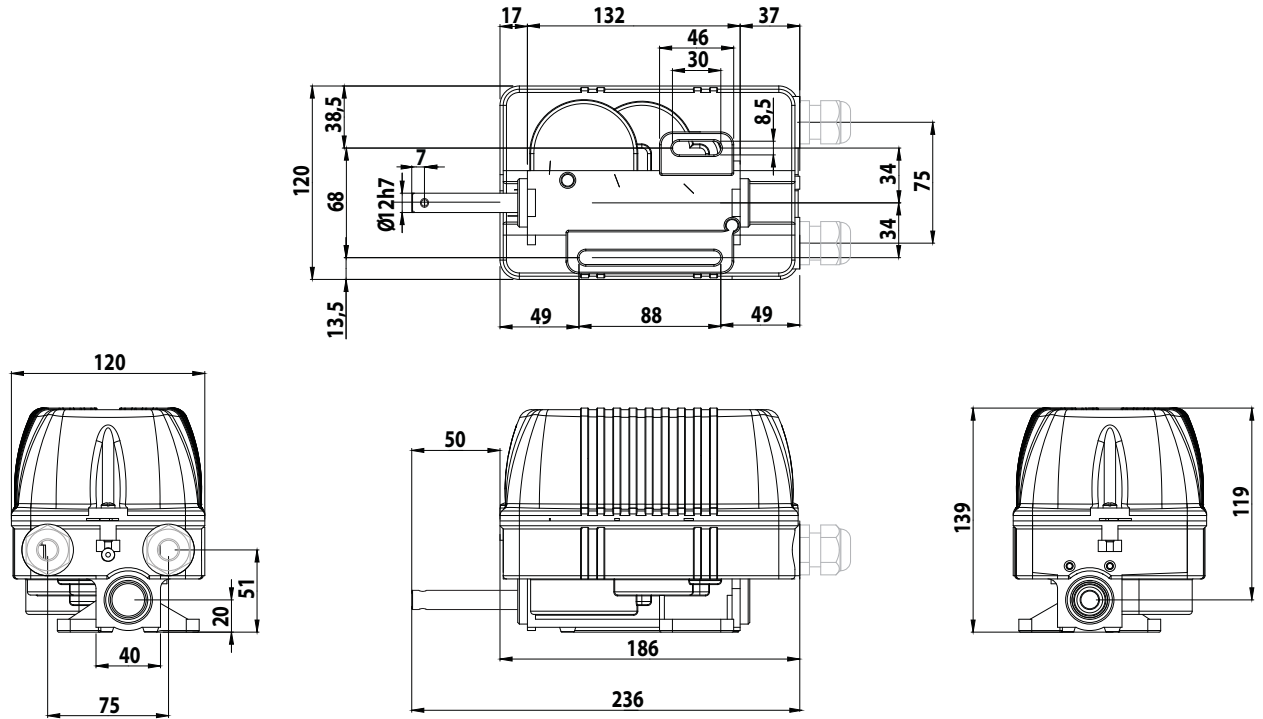

WITH FLANGE

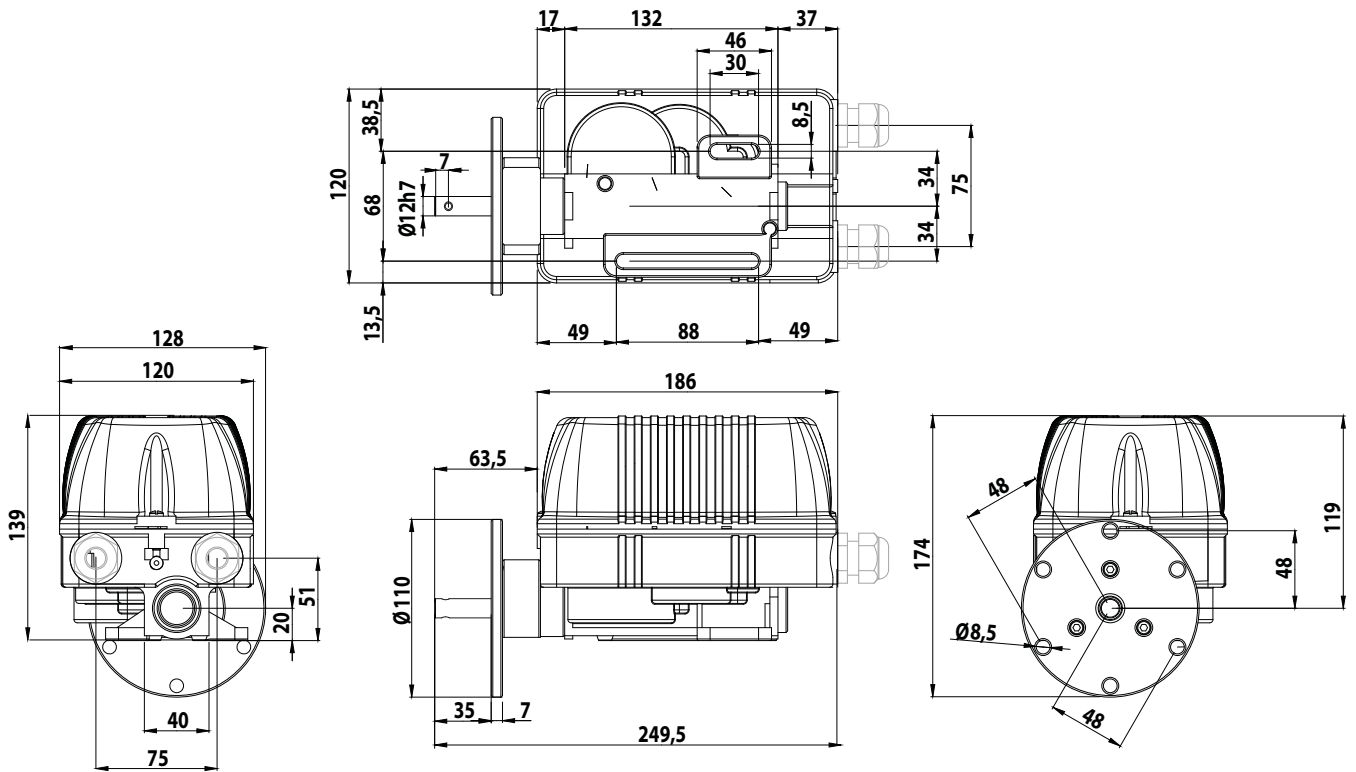

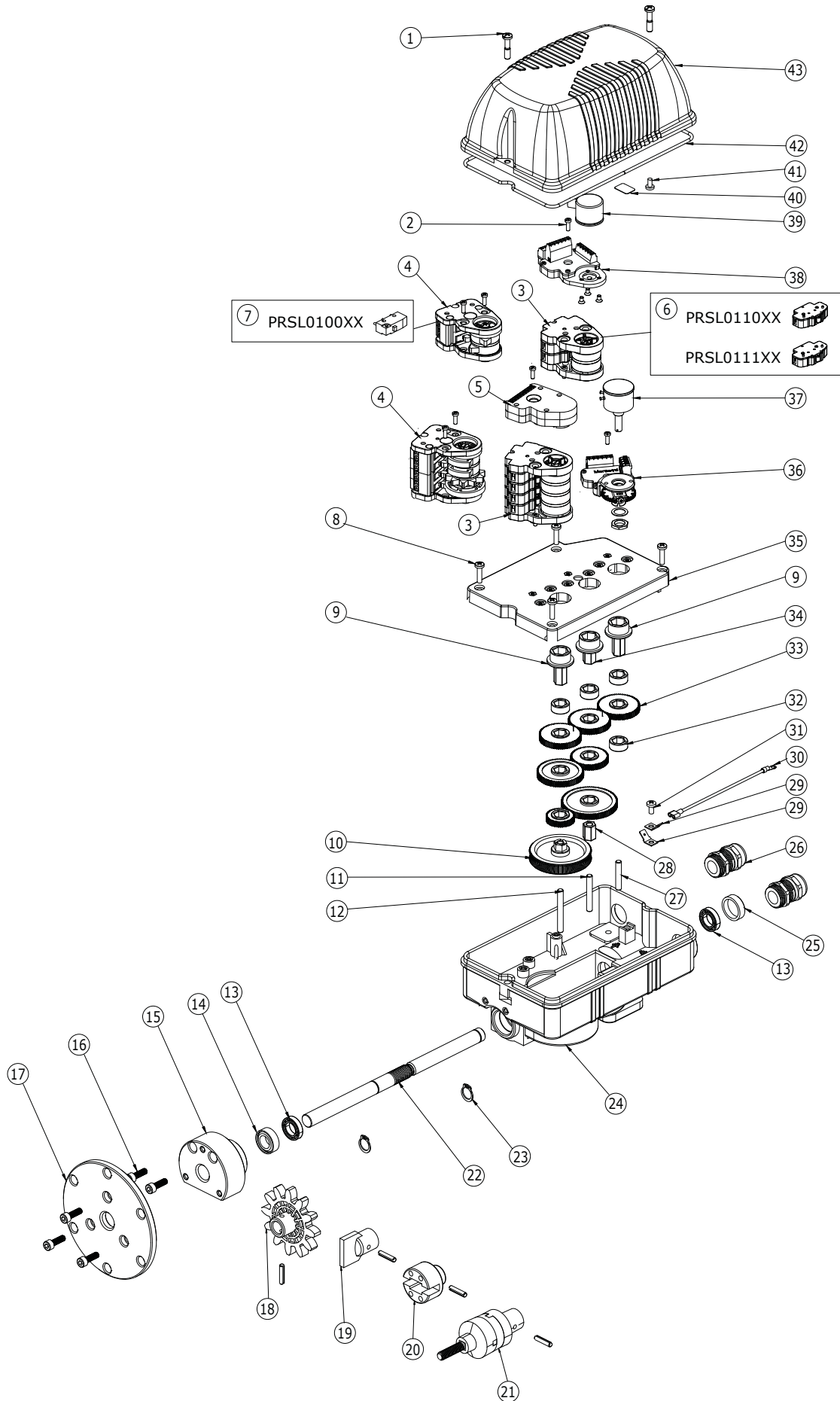

The data and the products illustrated in this brochure may be modified without notice. Under no circumstances can their description have a contractual value.



TER Tecno Elettrica Ravasi srl

Via Garibaldi 29/31 - 23885 Calco (LC) - Italy

Registered Office - via San Vigilio 2 - 23887 Olgiate Molgora (LC) - Italy

Tel. +39 0399911011 - Fax +39 0399910445 - E-mail: info@terworld.com

www.terworld.com

COMPONENTS







SWITCHES

REF	DRAWING	DESCRIPTION	SCHEME	CODE
6		1NO+1NC switch double break, snap action		PRSL0110XX
		1NC switch double break, slow action		PRSL0111XX
7		1NO+1NC switch single break, snap action		PRSL0100XX





STANDARD CAM SETS

REF	DRAWING	NO. AND TYPE OF CAMS	NO. AND TYPE OF SWITCH	SET CODE	
3		2 cams D	2 PRSL0110XX switches	FCL20001	
		2 cams D	2 PRSL0111XX switches	FCL20002	
		Cams D+E	2 PRSL0110XX switches	FCL20003	
		Cams D+E	2 PRSL0111XX switches	FCL20004	
		2 cams E	2 PRSL0110XX switches	FCL20005	
		2 cams E	2 PRSL0111XX switches	FCL20006	
		Cams F + F + C + B	4 PRSL0110XX switches	FCL40001	
		Cams F + F + C + B	4 PRSL0111XX switches	FCL40002	
		4 cams D	4 PRSL0110XX switches	FCL40003	
		4 cams D	4 PRSL0111XX switches	FCL40004	
		Cams D + D + E + E	4 PRSL0110XX switches	FCL40005	
		Cams D + D + E + E	4 PRSL0111XX switches	FCL40006	
		4 cams E	4 PRSL0110XX switches	FCL40007	
		4 cams E	4 PRSL0111XX switches	FCL40008	
	4		Cams E + E + E + A	4 PRSL0110XX switches	FCL40009
			Cams E + E + E + A	4 PRSL0111XX switches	FCL40010
Cams D + D + A + A			4 PRSL0110XX switches	FCL40011	
		Cams D + D + A + A	4 PRSL0111XX switches	FCL40012	
		2 cams D	2 PRSL0100XX switches	FCN20001	
		Cams D+E	2 PRSL0100XX switches	FCN20002	
		2 cams E	2 PRSL0100XX switches	FCN20003	
		Cams F + F + C + B	4 PRSL0100XX switches	FCN40001	
		4 cams D	4 PRSL0100XX switches	FCN40002	
		Cams D + D + E + E	4 PRSL0100XX switches	FCN40003	
	4 cams E	4 PRSL0100XX switches	FCN40004		
	Cams E + E + E + A	4 PRSL0100XX switches	FCN40005		
	Cams D + D + A + A	4 PRSL0100XX switches	FCN40006		

Other sets with 2-3-4 or 5 cams/switches available on request.
PRSL0100XX only for 2 or 4 cam sets.

CAM REFERENCE CHART									
CAM	MECHANICAL ANGLE	CODE FOR PRSL0110XX PRSL0111XX SWITCHES	CODE FOR PRSL0100XX SWITCHES	CAM	MECHANICAL ANGLE	CODE FOR PRSL0110XX PRSL0111XX SWITCHES	CODE FOR PRSL0100XX SWITCHES		
A		180°	PRSL7191PI	PRSL7121PI	D		-	PRSL7194PI	PRSL7124PI
B		320°	PRSL7192PI	PRSL7122PI	E		60°	PRSL7195PI	PRSL7125PI
C		-	PRSL7193PI	PRSL7123PI	F		72°	PRSL7196PI	PRSL7126PI

SENSORS, POTENTIOMETERS AND ENCODERS

REF	DRAWING	DESCRIPTION	CODE
5		Yankee 1 - current outpt	PA01AA01
		Yankee 1 - voltage outpt	PA01AB01
		Yankee 1 - PWM output	PA01AC01
37+36		Potentiometer MCB 10 kΩ with support	PA020001
		Potentiometer MCB 10 kΩ mechanical stop with support	PA020002
		Potentiometer Sfernice 10 kΩ ±10% 4 pin with support	PA020003
		Potentiometer Sfernice 10 kΩ ±10% 3 pin with support	PA020004
		Potentiometer Sfernice 5 kΩ ±10% with support	PA020005
		Potentiometer Megatron 4.7 kΩ with support	PA020006
		Potentiometer Megatron 10 kΩ with support	PA020007
		Potentiometer Megatron 2.2 kΩ with support	PA020008
		Potentiometer Novoteknik 2KΩ with support	PA020009
36		Potentiometer support	PA020000
39+38		Encoder 36 pulses/rev. with support	PA030001
		Encoder 150 pulses/rev. with support	PA030002
38		Encoder support	PA030000

PINION GEARS

REF	DRAWING	DESCRIPTION	CODE
18		Pinion gear M10 Z12 with pin	PRSL0911PI
		Pinion gear M12 Z10 with pin	PRSL0912PI
		Pinion gear M14 Z10 with pin	PRSL0913PI
		Pinion gear M16 Z10 with pin	PRSL0914PI
		Pinion gear M20 Z8 with pin	PRSL0915PI
		Pinion gear M5 Z12 with pin	PRSL0916PI
		Pinion gear M6 Z11 with pin	PRSL0917PI
		Pinion gear M8 Z12 with pin	PRSL0918PI
		Pinion gear M12 Z12 with pin	PRSL0944PI

Other pinion gears available: see "Gears and pinion gears" catalog

The data and the products illustrated in this brochure may be modified without notice. Under no circumstances can their description have a contractual value.



TER Tecno Elettrica Ravasi srl

Via Garibaldi 29/31 - 23885 Calco (LC) - Italy



Registered Office - via San Vigilio 2 - 23887 Olgiate Molgora (LC) - Italy

Tel. +39 0399911011 - Fax +39 0399910445 - E-mail: info@terworld.com

www.terworld.com

STANDARD LIMIT SWITCHES

All standard limit switches are equipped with cams PRSL7194PI  for PRSL0110XX and PRSL0111XX switches, PRSL7124PI  for PRSL0100XX switches and shafts made of stainless steel AISI 303

RATED REVOLUTION RATIO	REAL REVOLUTION RATIO	NUMBER OF CAMS AND SWITCHES	SWITCHES		
			PRSL0100XX  1 NO + 1 NC	PRSL0110XX  1 NO + 1 NC	PRSL0111XX  1 NC
			CODE	CODE	CODE
1 : 1	1 : 1	2	PFD9067A0001001	PFD9067L0001002	PFD9067L0001008
		4	PFD9067A0001002	PFD9067L0001003	PFD9067L0001009
		4 + 2	PFD9067A0001003	PFD9067L0001004	PFD9067L0001010
		4 + 4	PFD9067A0001004	PFD9067L0001005	PFD9067L0001011
		4 + 4 + 2	PFD9067A0001005	PFD9067L0001006	PFD9067L0001012
		4 + 4 + 4	PFD9067A0001006	PFD9067L0001007	PFD9067L0001013
1 : 5	1 : 5	2	PFD9067A0005001	PFD9067L0005004	PFD9067L0005008
		4	PFD9067A0005002	PFD9067L0005005	PFD9067L0005009
		4 + 2	PFD9067A0005003	PFD9067L0005006	PFD9067L0005010
		4 + 4	PFD9067A0005004	PFD9067L0005002	PFD9067L0005011
		4 + 4 + 2	PFD9067A0005005	PFD9067L0005007	PFD9067L0005012
		4 + 4 + 4	PFD9067A0005006	PFD9067L0005003	PFD9067L0005013
1 : 10	1 : 10	2	PFD9067A0010001	PFD9067L0010008	PFD9067L0010012
		4	PFD9067A0010002	PFD9067L0010005	PFD9067L0010013
		4 + 2	PFD9067A0010003	PFD9067L0010004	PFD9067L0010014
		4 + 4	PFD9067A0010004	PFD9067L0010009	PFD9067L0010015
		4 + 4 + 2	PFD9067A0010005	PFD9067L0010010	PFD9067L0010016
		4 + 4 + 4	PFD9067A0010006	PFD9067L0010011	PFD9067L0010017
1 : 15	1 : 15,92	2	PFD9067A0015001	PFD9067L0015003	PFD9067L0015009
		4	PFD9067A0015002	PFD9067L0015004	PFD9067L0015010
		4 + 2	PFD9067A0015003	PFD9067L0015005	PFD9067L0015011
		4 + 4	PFD9067A0015004	PFD9067L0015006	PFD9067L0015012
		4 + 4 + 2	PFD9067A0015005	PFD9067L0015007	PFD9067L0015013
		4 + 4 + 4	PFD9067A0015006	PFD9067L0015008	PFD9067L0015014
1 : 20	1 : 20	2	PFD9067A0020001	PFD9067L0020006	PFD9067L0020009
		4	PFD9067A0020002	PFD9067L0020002	PFD9067L0020010
		4 + 2	PFD9067A0020003	PFD9067L0020003	PFD9067L0020011
		4 + 4	PFD9067A0020004	PFD9067L0020007	PFD9067L0020012
		4 + 4 + 2	PFD9067A0020005	PFD9067L0020004	PFD9067L0020013
		4 + 4 + 4	PFD9067A0020006	PFD9067L0020008	PFD9067L0020014
1 : 25	1 : 25	2	PFD9067A0025001	PFD9067L0025009	PFD9067L0025012
		4	PFD9067A0025002	PFD9067L0025004	PFD9067L0025013
		4 + 2	PFD9067A0025003	PFD9067L0025005	PFD9067L0025014
		4 + 4	PFD9067A0025004	PFD9067L0025010	PFD9067L0025015
		4 + 4 + 2	PFD9067A0025005	PFD9067L0025006	PFD9067L0025016
		4 + 4 + 4	PFD9067A0025006	PFD9067L0025011	PFD9067L0025017

The data and the products illustrated in this brochure may be modified without notice. Under no circumstances can their description have a contractual value.



TER Tecno Elettrica Ravasi srl



Via Garibaldi 29/31 - 23885 Calco (LC) - Italy

Registered Office - via San Vigilio 2 - 23887 Olgiate Molgora (LC) - Italy

Tel. +39 0399911011 - Fax +39 0399910445 - E-mail: info@terworld.com

www.terworld.com

SWITCHES

RATED REVOLUTION RATIO	REAL REVOLUTION RATIO	NUMBER OF CAMs AND SWITCHES	PRSL0100XX	PRSL0110XX	PRSL0111XX
			 1 NO + 1 NC	 1 NO + 1 NC	 1 NC
			CODE	CODE	CODE
1 : 50	1 : 50	2	PFD9067A0050001	PFD9067L0050009	PFD9067L0050013
		4	PFD9067A0050002	PFD9067L0050010	PFD9067L0050016
		4 + 2	PFD9067A0050003	PFD9067L0050011	PFD9067L0050017
		4 + 4	PFD9067A0050004	PFD9067L0050012	PFD9067L0050018
		4 + 4 + 2	PFD9067A0050005	PFD9067L0050014	PFD9067L0050019
		4 + 4 + 4	PFD9067A0050006	PFD9067L0050015	PFD9067L0050020
1 : 75	1 : 75	2	PFD9067A0075001	PFD9067L0075002	PFD9067L0075009
		4	PFD9067A0075002	PFD9067L0075004	PFD9067L0075003
		4 + 2	PFD9067A0075003	PFD9067L0075005	PFD9067L0075010
		4 + 4	PFD9067A0075004	PFD9067L0075006	PFD9067L0075011
		4 + 4 + 2	PFD9067A0075005	PFD9067L0075007	PFD9067L0075012
		4 + 4 + 4	PFD9067A0075006	PFD9067L0075008	PFD9067L0075013
1 : 100	1 : 100	2	PFD9067A0100001	PFD9067L0100013	PFD9067L0100020
		4	PFD9067A0100002	PFD9067L0100015	PFD9067L0100021
		4 + 2	PFD9067A0100003	PFD9067L0100016	PFD9067L0100022
		4 + 4	PFD9067A0100004	PFD9067L0100017	PFD9067L0100023
		4 + 4 + 2	PFD9067A0100005	PFD9067L0100018	PFD9067L0100024
		4 + 4 + 4	PFD9067A0100006	PFD9067L0100019	PFD9067L0100025
1 : 150	1 : 150	2	PFD9067A0150001	PFD9067L0150007	PFD9067L0150012
		4	PFD9067A0150002	PFD9067L0150005	PFD9067L0150013
		4 + 2	PFD9067A0150003	PFD9067L0150008	PFD9067L0150014
		4 + 4	PFD9067A0150004	PFD9067L0150009	PFD9067L0150015
		4 + 4 + 2	PFD9067A0150005	PFD9067L0150010	PFD9067L0150016
		4 + 4 + 4	PFD9067A0150006	PFD9067L0150011	PFD9067L0150017
1 : 200	1 : 200	2	PFD9067A0200001	PFD9067L0200004	PFD9067L0200009
		4	PFD9067A0200002	PFD9067L0200005	PFD9067L0200010
		4 + 2	PFD9067A0200003	PFD9067L0200006	PFD9067L0200011
		4 + 4	PFD9067A0200004	PFD9067L0200002	PFD9067L0200012
		4 + 4 + 2	PFD9067A0200005	PFD9067L0200007	PFD9067L0200013
		4 + 4 + 4	PFD9067A0200006	PFD9067L0200008	PFD9067L0200014
1 : 250	1 : 250	2	PFD9067A0250001	PFD9067L0250012	PFD9067L0250016
		4	PFD9067A0250002	PFD9067L0250013	PFD9067L0250010
		4 + 2	PFD9067A0250003	PFD9067L0250009	PFD9067L0250017
		4 + 4	PFD9067A0250004	PFD9067L0250001	PFD9067L0250018
		4 + 4 + 2	PFD9067A0250005	PFD9067L0250014	PFD9067L0250019
		4 + 4 + 4	PFD9067A0250006	PFD9067L0250015	PFD9067L0250011
1 : 300	1 : 300	2	PFD9067A0300001	PFD9067L0300004	PFD9067L0300010
		4	PFD9067A0300002	PFD9067L0300005	PFD9067L0300011
		4 + 2	PFD9067A0300003	PFD9067L0300006	PFD9067L0300012
		4 + 4	PFD9067A0300004	PFD9067L0300007	PFD9067L0300013
		4 + 4 + 2	PFD9067A0300005	PFD9067L0300008	PFD9067L0300014
		4 + 4 + 4	PFD9067A0300006	PFD9067L0300009	PFD9067L0300015
1 : 450	1 : 450	2	PFD9067A0450001	PFD9067L0450001	PFD9067L0450008
		4	PFD9067A0450002	PFD9067L0450003	PFD9067L0450002
		4 + 2	PFD9067A0450003	PFD9067L0450004	PFD9067L0450009
		4 + 4	PFD9067A0450004	PFD9067L0450005	PFD9067L0450010
		4 + 4 + 2	PFD9067A0450005	PFD9067L0450006	PFD9067L0450011
		4 + 4 + 4	PFD9067A0450006	PFD9067L0450007	PFD9067L0450012

TOP - REQUEST FORM FOR NON STANDARD LIMIT SWITCHES

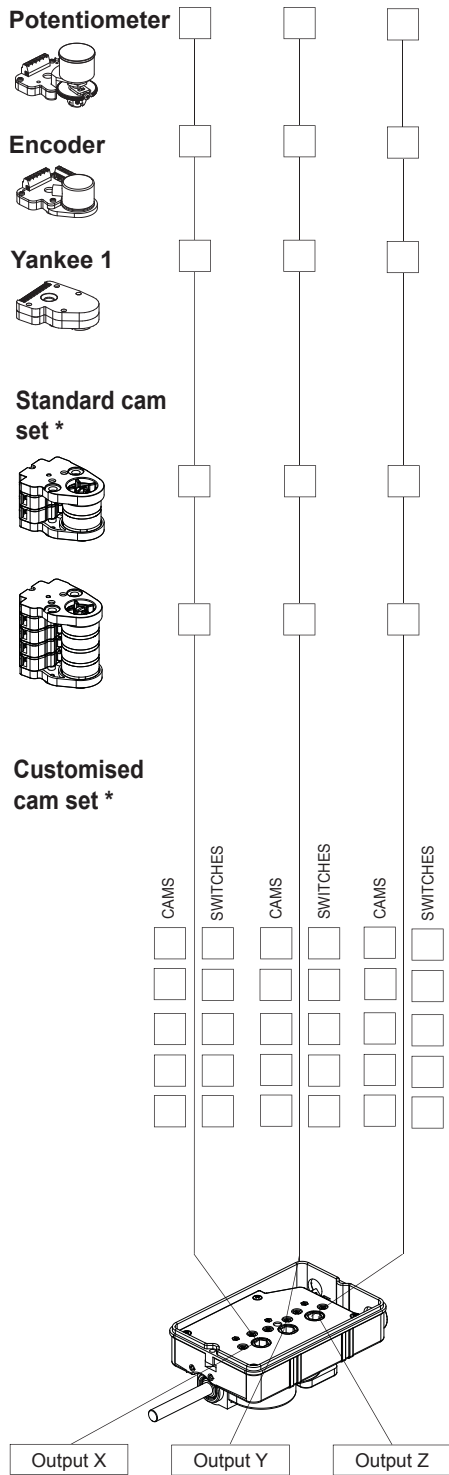

* Mark the number corresponding to the cam set required, if standard; otherwise mark the letters corresponding to the single cams and switches required. PRSL0100XX only for 2 or 4 cam sets.

Standard cam sets

Cams

	PRSL0100XX	PRSL0110XX	PRSL0111XX
D D	1	11	21
D E	2	12	22
E E	3	13	23
F F C B	4	14	24
D D D D	5	15	25
D D E E	6	16	26
E E E E	7	17	27
E E E A	8	18	28
D D A A	9	19	29

Cams

	Codes for PRSL0110XX PRSL0111XX switches	Codes for PRSL0100XX switches
A (180°)	PRSL7191PI	PRSL7121PI
B (320°)	PRSL7192PI	PRSL7122PI
C	PRSL7193PI	PRSL7123PI
D	PRSL7194PI	PRSL7124PI
E (60°)	PRSL7195PI	PRSL7125PI
F (72°)	PRSL7196PI	PRSL7126PI

(Degrees correspond to mechanical angle)

Switches

<input type="checkbox"/> X	PRSL0100XX
<input type="checkbox"/> Y	PRSL0110XX
<input type="checkbox"/> Z	PRSL0111XX

Encoder

<input type="checkbox"/> R	PA030001
<input type="checkbox"/> S	PA030002

Yankee 1

<input type="checkbox"/> T	PA01AA01
<input type="checkbox"/> U	PA01AB01
<input type="checkbox"/> V	PA01AC01

Potentiometer

<input type="checkbox"/> G	PA020001	<input type="checkbox"/> N	PA020006
<input type="checkbox"/> H	PA020002	<input type="checkbox"/> O	PA020007
<input type="checkbox"/> I	PA020003	<input type="checkbox"/> P	PA020008
<input type="checkbox"/> L	PA020004	<input type="checkbox"/> Q	PA020009
<input type="checkbox"/> M	PA020005		

Revolution ratio

Output X Y Z			Ratio	Output X Y Z			Ratio
<input type="checkbox"/>	<input type="checkbox"/>	<input type="checkbox"/>	1:1	<input type="checkbox"/>	<input type="checkbox"/>	<input type="checkbox"/>	1:150
<input type="checkbox"/>	<input type="checkbox"/>	<input type="checkbox"/>	1:5	<input type="checkbox"/>	<input type="checkbox"/>	<input type="checkbox"/>	1:200
<input type="checkbox"/>	<input type="checkbox"/>	<input type="checkbox"/>	1:10	<input type="checkbox"/>	<input type="checkbox"/>	<input type="checkbox"/>	1:250
<input type="checkbox"/>	<input type="checkbox"/>	<input type="checkbox"/>	1:15	<input type="checkbox"/>	<input type="checkbox"/>	<input type="checkbox"/>	1:300
<input type="checkbox"/>	<input type="checkbox"/>	<input type="checkbox"/>	1:20	<input type="checkbox"/>	<input type="checkbox"/>	<input type="checkbox"/>	1:450
<input type="checkbox"/>	<input type="checkbox"/>	<input type="checkbox"/>	1:25	<input type="checkbox"/>			1: <input type="text"/>
<input type="checkbox"/>	<input type="checkbox"/>	<input type="checkbox"/>	1:50	<input type="checkbox"/>			1: <input type="text"/>
<input type="checkbox"/>	<input type="checkbox"/>	<input type="checkbox"/>	1:75	<input type="checkbox"/>			1: <input type="text"/>
<input type="checkbox"/>	<input type="checkbox"/>	<input type="checkbox"/>	1:100				

- Male coupling
- Female coupling
- Coupling
- Flange

- Standard shaft
- Flexible shaft

Pinion gear

<input type="checkbox"/>	PRSL0911PI	M10 Z12
<input type="checkbox"/>	PRSL0912PI	M12 Z10
<input type="checkbox"/>	PRSL0913PI	M14 Z10
<input type="checkbox"/>	PRSL0914PI	M16 Z10
<input type="checkbox"/>	PRSL0915PI	M20 Z8
<input type="checkbox"/>	PRSL0916PI	M5 Z12
<input type="checkbox"/>	PRSL0917PI	M6 Z11
<input type="checkbox"/>	PRSL0918PI	M8 Z12
<input type="checkbox"/>	PRSL0944PI	M12 Z12
<input type="checkbox"/>	Customised	M <input type="text"/> Z <input type="text"/>

The data and the products illustrated in this brochure may be modified without notice. Under no circumstances can their description have a contractual value.



TER Tecno Elettrica Ravasi srl

Via Garibaldi 29/31 - 23885 Calco (LC) - Italy
 Registered Office - via San Vigilio 2 - 23887 Olgiate Molgora (LC) - Italy
 Tel. +39 0399911011 - Fax +39 0399910445 - E-mail: info@terworld.com

www.terworld.com

Top rotary limit switch is an electromechanical device for low voltage control circuits (EN 60947-1, EN 60947-5-1) to be used as electrical equipment on machines (EN 60204-1) in compliance with the fundamental requirements of the Low Voltage Directive 2006/95/CE and of the Machine Directive 2006/42/CE.

The limit switch is designed for use in industrial environments under even severe climatic conditions (operational temperature from -40°C to $+80^{\circ}\text{C}$, suitable for use in tropical environment). The equipment can be used in environments having a high percentage of sodium chloride (saline fog). The equipment is not suitable for use in environments with potentially explosive atmosphere or corrosive agents. Oils, acids or solvents may damage the equipment; avoid using them for cleaning. Do not connect more than one phase to each switch. Do not oil or grease the control elements or the switches.

The installation of the limit switch shall be carried out by expert and trained personnel. Wiring shall be properly done according to the current instructions.

Prior to the installation and the maintenance of the limit switch, the main power of the machinery shall be turned off.

Steps for the proper installation of the limit switch

- loosen the fixing screw (4) and remove the cover (3)
- connect the limit switch shaft (2) to the reduction gear shaft
- fix the limit switch firmly in place to prevent abnormal vibrations of the equipment during operation; use only the fixing holes on the base or the flange (1) to fix the equipment
- insert the cable into the limit switch through the cable clamp (5)
- strip the cable to a length suitable for wiring the switches
- tape the stripped part of the cable
- clamp the wire into the cable clamp (5)
- when PRSL0110XX and PRSL0111XX switches are used connect the switches according to the contact scheme printed on the switches or to the wiring scheme on the back of the instructions (tighten the wires into the terminals with a torque equal to 0.5 Nm; (UL (c)UL: use 60°C or 75°C copper (CU) conductors and stiff or flexible wire 14-16 AWG); insertability of wires into the terminals $2 \times 0.5 \text{ mm}^2$ $2 \times 1.5 \text{ mm}^2$ $1 \times 2.5 \text{ mm}^2$)
- when PRSL0100XX switches are used connect the terminals according to the contact scheme printed on the label placed on the cam set (tighten the wires to the terminals with a torque of 50/60 cNm; insertability of wires into the terminals $0.25/1.5 \text{ mm}^2$)
- connect the ground wire to the terminal screwed on the metal base (6) of the equipment (Class I equipment) (tighten the wire into the terminals with a torque equal to 80 cNm; insertability of wires into the terminal equal to $2 \times 1.5 \text{ mm}^2 - 1 \times 2.5 \text{ mm}^2$) (or with a Faston connection)
- connect the ground wire (9), cabled to the cover, to the appropriate ground terminal Faston (10) screwed on the metal base (6)
- adjust the operating point of the cams; for proper adjustment, loosen the central screw (7) of the cam set, adjust the operating point of each single cam by turning its screw (8) (the numbers on the screws refer to the cams counting from bottom to top of the set), then tighten the central screw (7)
- close the limit switch checking the proper positioning of the rubber in the cover (3) and tighten the screws (4) with a torque of 450/500 cNm

Steps for routine maintenance

- check the proper tightening of the screws (4) and cover (3)
- check the proper tightening of the switch terminal screws
- check the proper tightening of the central screw (7) holding the cams
- check the wiring conditions (in particular where wires clamp into the switch)
- check the conditions of the rubber fit into the cover (3) and check the tightening of the cable clamp (5) around the cable
- check that the limit switch enclosure (3, 6) is not broken
- check the alignment between the limit switch shaft (2) and the reduction gear shaft
- check that the limit switch is properly fixed
- if there is an anti-moisture plug, check its conditions

In case any component of the limit switch is modified, the validity of the markings and the guarantee on the equipment are annulled. Should any component need replacement, use original spare parts only.

TER declines all responsibility for damages caused by the improper use or installation of the equipment.

Technical Specifications UL with PRSL0110XX and PRSL0111XX switches

Code Top certified UL = PFD9U67L XXXX XXX

= PFD9U67M XXXX XXX

Contact Blocks Rating = A600, Q600

Environmental Rating = Type 3

Cord diameter range = from 0.31 in (8 mm) to 0.51 in (13mm)

Cord type = flexible, type minimum SW or SJW (ZJCZ/7)

Wire size range = 14-16 AWG stranded or solid

Conductors = Copper (CU) $60/75^{\circ}\text{C}$

Terminal tightening torque = 4.50 lb.in (0.5Nm)

Marking = 

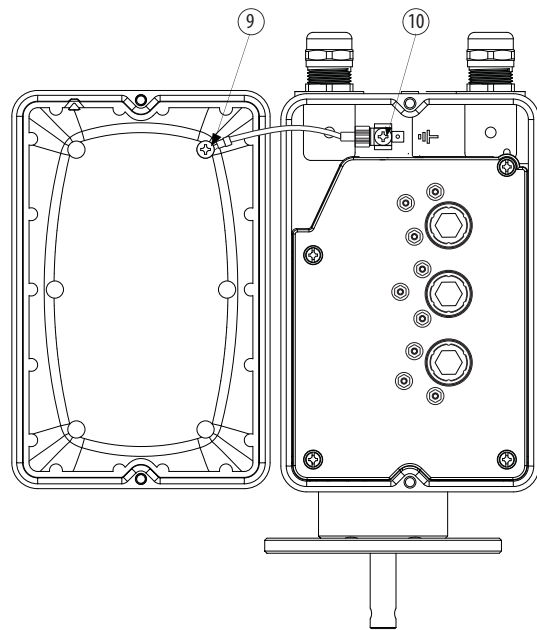
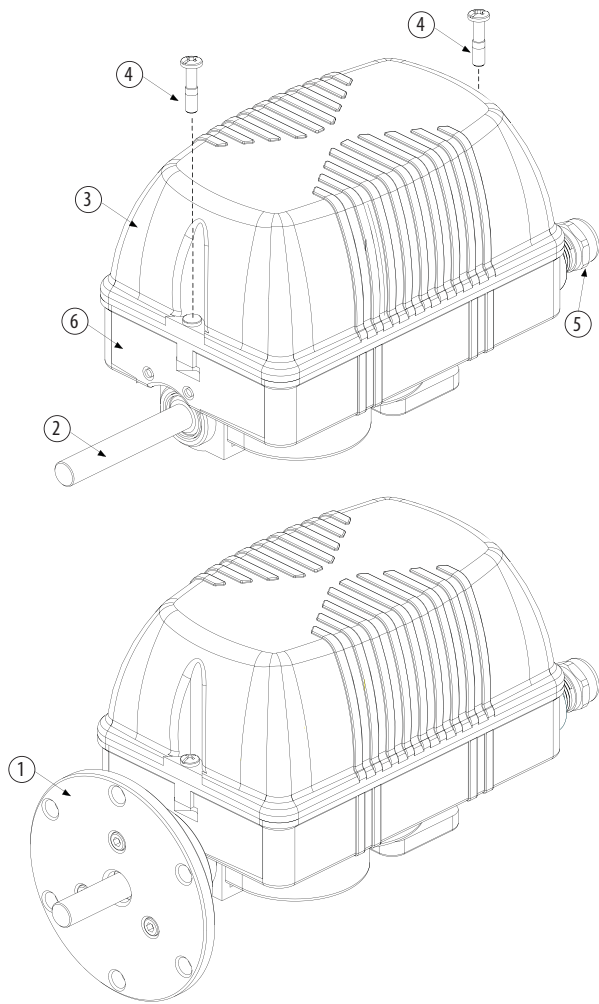

Cam set with PRSL0110XX or PRSL0111XX switches

Cam set with PRSL0100XX switches

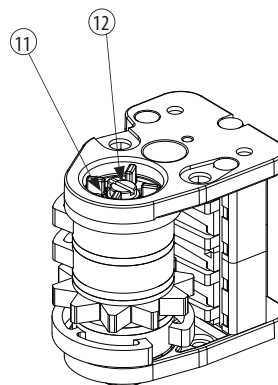
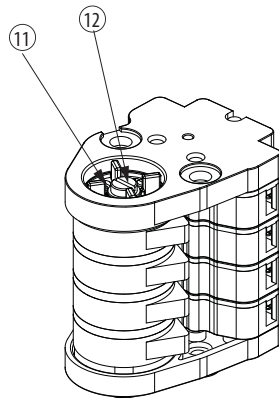

*Image for illustrative purpose
the number and type of cams is different according to the model*

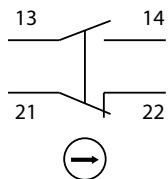

Wiring Layout Switches
PRSL0110XX

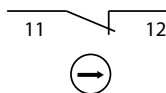

Wiring Layout Switches
PRSL0111XX

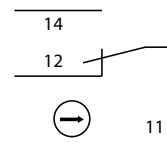

Wiring Layout Switches
PRSL0100XX

The data and the products illustrated in this brochure may be modified without notice. Under no circumstances can their description have a contractual value.



TER Tecno Elettrica Ravasi srl

Via Garibaldi 29/31 - 23885 Calco (LC) - Italy

Registered Office - via San Vigilio 2 - 23887 Olgiate Molgora (LC) - Italy

Tel. +39 0399911011 - Fax +39 0399910445 - E-mail: info@terworld.com

www.terworld.com